



Plastics Shape the Future

Connected Technologies and Material / Product Circulation

The 33rd

# NAGOYA PLASTIC INDUSTRIAL FAIR 2021

Guide to Exhibit

Sep.29 [Wed.]  Oct.1 [Fri.]

Portmesse Nagoya (Nagoya International Exhibition Hall)

<https://nagoya-platen.com/>

# Introduction

In April 2020, the Japanese Government declared a state of emergency in response to the spread of COVID-19, and it has had a major impact on the manufacturing industry of our country. People's lifestyles are forced to change amidst the COVID-19 crisis. Adapting to the "New Normal" has become an important issue after the state of emergency has been lifted.

In order to overcome this adversity, we believe we must strengthen our international competitiveness in this new state by further enhancing our technological innovation and manufacturing skills. The Chubu region (Central Japan), where manufacturing companies and technologies gather, is expected to be the leading force to open up this new ground.

Under these circumstances, the Central Japan Plastics Federation, Central Japan Plastic Products Industry Association, and Nikkan Kogyo Shimbun will host the "Nagoya Plastic Industrial Fair 2021" for 3 days from September 29 to October 1 at Portmesse Nagoya. The "Nagoya Plastic Industrial Fair" has been held once every 3 years ever since its first show held in 1963. It is one of the biggest shows in the Chubu area focusing on the plastic industry, thoroughly covering areas from raw materials, molding machines, secondary processing machines, molding related equipment, compound equipment, 3D printers, molds, measuring devices, products to recycling technology.

In aiming to introduce our visitors to highly functional and networked machines and manufacturing technologies in which create materials and products that are compatible to a digital, sustainable, and recycling society.

Under the theme "Plastics Shape the Future: Connected Technologies and Material/Product Circulation," the latest technologies, products and services in the plastic industry will be widely exhibited. We hope that you can use it as a place to look for new business connections and expand your sales channels. We look forward to your participation.

September 2020  
Central Japan Plastics Federation  
Central Japan Plastic Products Industry Association  
Nikkan Kogyo Shimbun

## Event Outline

- Show Name** Nagoya Plastic Industrial Fair 2021
- Theme** Plastics Shape the Future : Connected Technologies and Material / Product Circulation
- Date** September 29th (Wed.) -October 1st (Fri.), 2021
- Opening Hours** 10:00-17:00 (10:00-16:00 on the last day)
- Venue** Portmesse Nagoya (Nagoya International Exhibition Hall), Third Exhibition Hall
- Organizer** Central Japan Plastics Federation, Central Japan Plastic Products Industry Association, Nikkan Kogyo Shimbun
- Supporting Organizations** Chubu Bureau of Economy, Trade and Industry, Aichi Prefecture, Nagoya City, Nagoya Chamber of Commerce & Industry (to be confirmed)  
The Society of Japanese Aerospace Companies, Japan Robot Association, Japan Auto Parts Industries Association, The Japan Society of Industrial Machinery Manufacturers, The Japan Reinforced Plastics Society, All Japan Plastic Products Industrial Federation, Association of Japan Plastics Machinery, Japan Society of Plastics Technology, Japan Precision Measuring Instruments Manufacturers Association, Plastic Waste Management Institute, The Japan Carbon Fiber Manufacturers Association, Central Japan Plastic Mold Association, Aichi Plastic Mold Industrial Association, Gifu Plastic Industrial Association, Ishikawa Plastics Evolution Cooperative (in random order, to be confirmed)
- Admission Fee** JPY 1,000 (Free for pre-registered guests, guests with invitation tickets, high school aged students and below)



### Co-located Events

- Special Seminar
- Technology Seminar
- Exhibitor Presentations etc.



# Important Information

## Exhibition Space Fee

1 Booth: W2,970mm × D2,970mm × H2,700mm  
Rate per 9 sqm. (tax included)

- Indoor Booth JPY 264,000
- Island Booth (6 + units) JPY 237,600
- Outdoor Booth JPY 132,000

## Application and Inquiry

To apply, please fill out the Application Form and send it by email to ACT INTERNATIONAL, the agent for overseas exhibitors as below.

## Overseas Agent

ACT INTERNATIONAL, INC.  
ACT Aoyama Bldg. 2A, 2-9-18  
Minamiaoyama, Minato-ku, Tokyo 107-0062  
TEL: +81-3-5770-5581  
Email: exhibition@actinter.co.jp

## Exhibitor Application Deadline

April 30th, 2021  
\*Please note that the list will be closed before the deadline once all available spaces are fully booked.

## Cancellation or Modification of the Contract

As a general rule, organizers will not accept any cancellations or modifications of the exhibit booth contract once the application is received by the organizer (or overseas agent). However, in the event that an application must be canceled, it will be accepted with the following additional fee;

Date of Cancellation	Cancellation Fee
Until June 29th, 2021	50% of exhibition space fee
After June 30th, 2021	100% of exhibition space fee

## Booth Allocation

Exhibitor booth locations will be determined by the organizer with consideration to the contents of the exhibit, past participation records, and the entire hall layout. Exhibitors will be informed of their booth location around the end of June 2021 at the earliest. Exhibitors are not allowed to sell or lend part or all of their allocated space without the approval of the organizer.

## Rental Booth Package

extra charge

This simple decoration package enables exhibitors to save exhibit costs. Please contact the overseas agent if you are interested.

- |                       |   |
|-----------------------|---|
| 1 Fascia (white)      | 1 Socket  |
| Company name plate    | Carpet  |
| 1 Information counter | 2 Fluorescent lights (40W)                            |
| 1 Folding chair       | Electrical installation fee and electricity fee (1kw) |
| 1 Business card box   | Including installation and dismantling fee            |

**JPY 81,400 per booth (tax included)**

(e.g.) If you apply for one booth with the above package, the total exhibit cost will be...

Exhibit space fee: JPY 264,000 + Rental Booth Package JPY 81,400= JPY 345,400 (tax included)

\*The package can also be applied to exhibitors with more than 2 units.  
Please contact the overseas agent for more details on the package and also for custom designed booths.

## Booth Details

### Size

Basic Booth Size  
1 Booth: W2,970mm × D2,970mm × H2,700mm

### Inline Booth

- 1) Comes with a back wall, side walls and protruding company name plates.
- 2) Back and side walls will be white system panels.
- 3) For corner booths, there will be no partition wall facing the aisle unless the exhibitor requests as such.

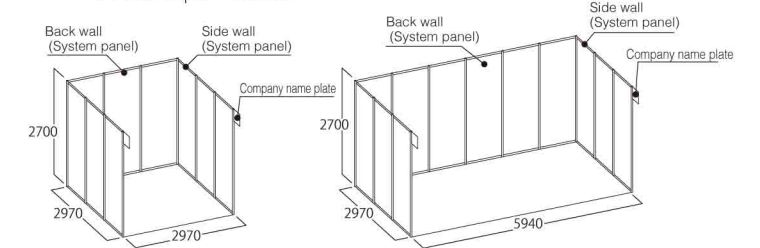

[e.g. 1 unit]  
(W2,970mm×D2,970mm×H2,700mm)  
\*No carpet.

[e.g. 2 units]  
(W5,940mm×D2,970mm×H2,700mm)  
\*No carpet.

### Peninsula Booth < 4 + units >

- 1) Partition wall and protruding company name plate.
- 2) The partition wall will be a white system panel.

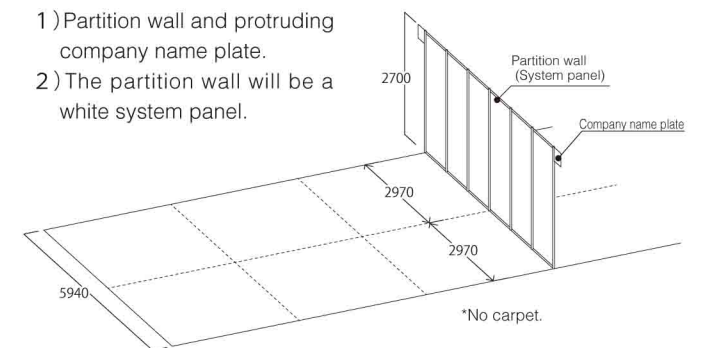

### Island Booth < 6 + units >

- 1) Space only, no partitions.
- 2) Protruding company name plates could be installed based on the exhibitor's request after the completion of their booth decoration.

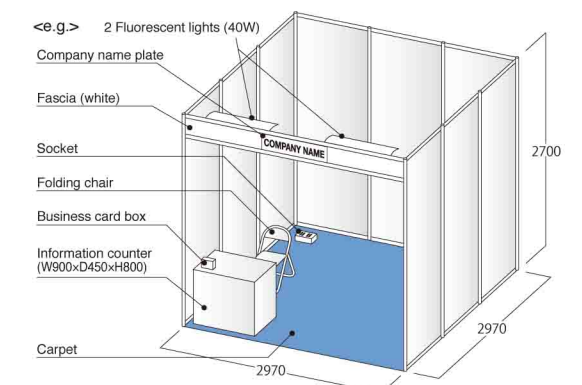
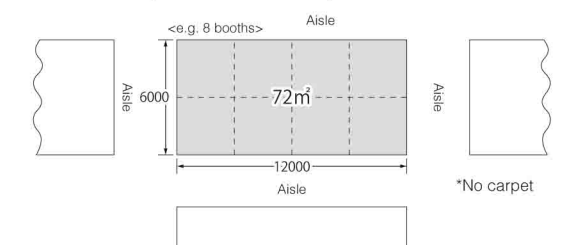

# Exhibitor Profiles / Zoning Image

## Plastic Machines

### ● Molding machines

Injection molding machine, Extrusion equipment, Blow molding machine, Thermoforming machine (Vacuum forming, Pressure forming), Compression molding machine, Inflation molding machine, Calendaring forming apparatus, Powder molding machine, Composite molding technology, Foam molding machine, Centrifugal molding equipment, FRP molding related equipment, Stereolithography/Rapid Prototyping Equipment, and other molding machines, etc.

### ● Molding related equipment / Peripheral devices

Take-out robot, Related industrial robot, Raw material mixing/supplying equipment (Hopper, Loader, Mixer, Quantitative mixing and feeding equipment, etc.), Automatic gate cutting equipment, Monitoring system, Array apparatus, Boxing related equipment, Conveyor, Take-up/winding device, Roll temperature controller, Raw material dryer, Centrifugal extractor, Crusher/Grinder, Automatic color changing device, Degassing equipment, Gas equipment, Lubrication system, Annealing machine, Pelletizer, Pellet sorter, Foreign substance removal apparatus, Automatic release agent sprayer, Hydraulic equipment, Transport/Supply system, Computer-aided software, and other molding-related equipment, etc.

### ● Secondary processing machines

Junction device (Hot air welding machine, Heat sealer, Impulse sealer, High-frequency welder, Ultrasonic welder, Friction welder, Laser welder, etc.), Surface decoration device (Hot stamping device, etc.), Printer, Coating machine/Plating, Machining equipment (Polishing machine, Grinding machine, Cutting machine, Punching press, Deburring machine, Die cutting machine, Laser processing machine, Hole punching machine, Engraving machine), etc.

### ● Molding machine parts / Accessories

Cylinders, screws, Heaters, Hydraulic equipment, Blowers, Filters, Extruders parts/Accessories, Motors, Rolls, Nozzles, Oil cleaners, Insulating board, Connectors/Joints/Hoses, Valves, Gears, Clamps, Ball screws, Roller screws, Bolts/Nuts, Bearings, Laser generators, Robot parts, etc.

### ● Polymerization / Compound equipment

Extruder, Kneader, Granulator, Pelletizer, Pump, Compressor, Meter, Automatic weighing system, Cooler, Dryer, Various sensors, Various analyzers, etc.

## Plastic 3D Molding / Processing

### ● Molding equipment, devices, peripheral equipment / Technology

AM, 3D printer, 3D scanner, 3D CAD, Laser processing machine, Stereolithography, CT/MRT/Image processing equipment, Surface treatment, Finishing, Printing equipment, Mold making equipment/Technology, Service bureau, Lightweight structure technology, Microtechnology, etc.

### ● Materials for 3D printers

Resin materials, Ceramic materials, Metal materials, Composite/Functional materials, etc.

### ● Software

3D visualization, 3D graphic/Modeling software, CAD/CAM system, CT/MRT/Image processing system, Simulation system, etc.

### ● Evaluation/Measurement / Control devices

Three-dimensional measuring device, Simulator, Laser measuring/Calibrator, Optical measuring technology, Various sensors, Various measuring device, Display system, etc.

## Raw Materials / Additives

Resin raw materials, Recycled materials, Rubber, Compounding agents/Additives (Fillers, Flame retardants, Antistatic agents, Antioxidants, Stabilizers, Plasticizers, Colorants, etc.), Purging agents, Raw materials for high-performance plastic, Functions materials, Coating materials, Resin compounds, Foamed resins, Special purpose resins, etc.

## FRP

Carbon fiber base material (PAN type, Pitch type), Carbon fiber composite material (CFRP, CFRTP, GFRP, KFRP, etc.), FRP resin, Autoclave device, Other FRP molding machine, Flame retardant/Hardener/Filler and various additives, Processing technology for FRP (Cutting, Trimming, Drilling, etc.), Three-dimensional measuring machine, Oven/Curing furnace, FRP molded product, Finished product, etc.

## Eco-friendly Plastics (Environmental Load Reduction Materials)

- Biodegradable plastic
- Cellulose nanofiber
- Plant-based plastic
- Recycled plastic etc.
- CO<sup>2</sup> reduction plastic

## Recycling / Waste Treatment Related Machines / Devices

Plastic recycler, Waste plastic grinder/Crusher, Washing device, Sorter/Separator, Dehydrator, Drying device, Melting device, Regenerated pellet manufacturing device, Volume reduction device, Fixing device, Oil reduction device, Incineration equipment, Collection service, etc.

## Factory Equipment / Smart Factory Related Machines / Devices

Factory air conditioning equipment, Dust removal equipment, Material handling equipment, Static eliminator, Water treatment equipment, Automation systems, Blast machines, Boilers, lubricants, etc. Production management/Systems, Communication equipment/Systems, Factory energy, Development support software, Service, etc.

## Measuring Devices / Control Devices

Thickness gauge, Dimensional measuring device, Thermometer, Hygrometer, Hardness meter, Viscometer, Pressure gauge, Moisture meter, Hydrometer, Spectrophotometer, Colorimeter, Torque rheometer, Various testing machines, Inspection equipment, Coordinate Measuring Machine, Controller, etc.

## Mold Related Equipment / Materials

Molds, Mold parts, Mold processing machines, Mold temperature controllers, Hot runner devices, Mold materials, Mold processing machine tools, CAD/CAM, Mold sensors, Mold design software, Storage shelves, etc.

## Products

Daily necessities, Office supplies, Electric parts, Automobile parts, Industrial products, Ultra-precision molded products, Industrial materials, Civil engineering/Building supplies, Packaging supplies, Medical/Safety supplies, Energy related parts, Information and communication equipment related parts, Optical parts, Decorations/Advertising products, Tubes/Hoses, Plates, Sheets, Tubes, Rods, Profiles, Films, Adhesives/Solvents, Anti-virus products (Face shields, Acrylic partitions, Masks, Protective clothing, Protective goggles, Non-contact items), Other plastic related products, etc.

## Others

Press, Book, Research, Consulting, Data, etc.

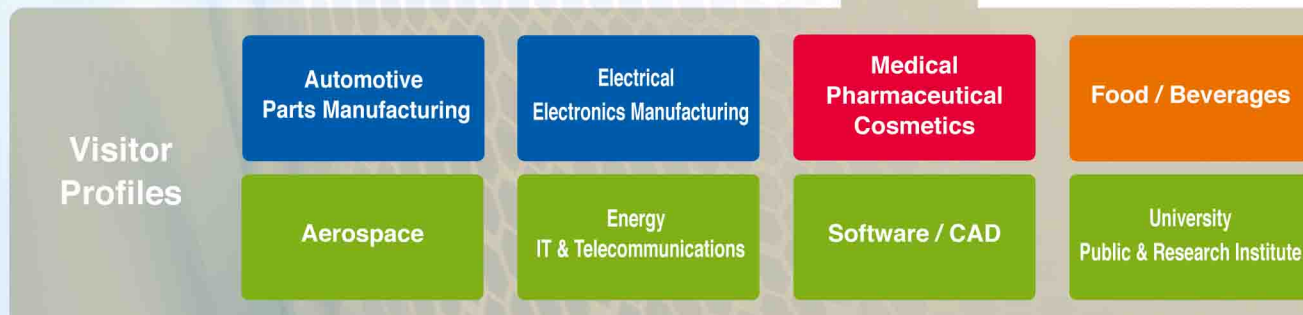

## About the Show

- The 33rd edition of the largest plastic exhibition in the Chubu region held once every three years.
- Expecting a unique range of visitors from the center of the manufacturing industry in Japan, the Chubu region.
- Organized by major plastic associations in the Chubu region, introducing new technology, products, and services.

## Why Exhibit?

- Links to exhibitor websites, providing detailed information to the visitors.
- Exhibitor interviews and serializations published on newspapers before the show by the organizing media company (for more details, please refer to show promotion).
- Exhibitors can make business presentations directly to the visitors (extra charge).

## Co-located Event

We will organize and conduct special seminars based on themes that meet the demand of the times. We aim to attract high quality visitors by widely transmitting the hottest information of the plastic industry.



The number of exhibitors in 2018: 123 companies / organizations, 465 booths

## Exhibiting Companies and Organizations Over the Past Three Shows

<b>A</b>	EYE GRAPHICS	MARUYASU	NTT DATA ENGINEERING SYSTEMS	THREE PEAKS GIKEN TOHOKU ELECTRONIC INDUSTRIAL
ACHILLES	FANUC	MATERION BRUSH JAPAN	O&M HEATER	TOKIWA INDUSTRY
AICHI PREFECTURE BLOOD CENTER	FUJIKIHAN	MATSUI MFG.	OKAMOTO INDUSTRIES	TOKUDEN
AICHI SHINSHIRO CITY	FUKURO INDUSTRIAL	MATSUMURA ALLOY	ORBIS	TOKYO IDEAL
AIKI INDUSTRY	<b>G</b>	DIES LABORATORY	ORION MACHINERY	TORAY ENGINEERING
AKASHIKASEI	GNEUSS	MEIEISHA	OSAKA DENSHI	TORAY INDUSTRIES
AMG	KUNSTSTOFFTECHNIK	MEIKI	<b>P</b>	TOSHIBA MACHINE
ASAI SANGYO	GOTO PLASTIC	MEIRYO JUSHI	PASCAL	TOYAMA COLORING
ASK INDEX	GREENTECH JAPAN	MIMAKI ENGINEERING	PHILIP MORRIS JAPAN	TOYO MACHINERY & METAL
<b>B</b>	GRP JAPAN	MINO GROUP	PLACO	TOYOTA AUTO BODY
BANDO CHEMICAL INDUSTRIES	<b>H</b>	MINO INTERNATIONAL	PLA MOUL SEIKO	TOYOTA MOTOR
<b>C</b>	HARMO	MISUMI	PLASCOAT	TREXEL JAPAN
CANON ELECTRONICS	HAYACK	MITSUBISHI CHEMICAL	PRINTOS	<b>U</b>
CENTRAL JAPAN PLASTIC PRODUCTS INDUSTRY ASSOCIATION	HOKULO SEIKOU	MITSUBISHI CHEMICAL HOLDINGS	PVC DESIGN AWARD (VINYL ENVIRONMENTAL COUNCIL)	UKAWA RUBBER MFG
- AICHI PLASTIC MOLD INDUSTRIAL ASSOCIATION	HOLON SEIKO	- MKV DREAM	<b>R</b>	UNITEK JAPAN
- AICHI PREFECTURAL GOVERNMENT	HORAI	- QUADRANT PLASTIC COMPOSITES JAPAN	REED ISG JAPAN	USHIO LIGHTING
- AICHI CENTER FOR INDUSTRY AND SCIENCE TECHNOLOGY	HSIN LIEN SHENG MACHINERY	- CHALLENGE	REIKEN	<b>V</b>
- AICHIJITSUGYO	<b>I</b>	MITSUBISHI RAYON	RF	VIDEOJET X-RITE
- IZUMI KASEI	I.O.M	MITSUBISHI UFJ	RHEO LAB	<b>W</b>
- KAMIMOTO JUSHI KOUGYOUSHO	IIDA KOGYO	LEASE & FINANCE	RIGAKU	WAINAM
- GIFU PLASTIC INDUSTRY	IKEGAMI SEIKI	MITSUI CHEMICAL	<b>S</b>	WATANABE SEIKOSHO
- SANKEI PLASTICS	INAC	ANALYSIS & CONSULTING SERVICE	SABLUX TECHNIK	WEDGE
- SANSYU PRECISION	ISHIDA TECNO	MOLDGIKEN	SAEILLO JAPAN	WEST JAPAN PLASTIC PRODUCTS INDUSTRIAL ASSOCIATION
- SUZUKI CHEMICAL INDUSTRY	ITS JAPAN	MOLE'S ACT	SAIKA TECHNOLOGICAL INSTITUTE	- KAKUICHI KASEI
- ALL JAPAN PLASTIC PRODUCTS INDUSTRIAL FEDERATION	<b>J</b>	MORITEQ	FOUNDATION	- SANKYO PLUS
- TAISEI PLAS	JAPAN DIE & MOLD INDUSTRY	MUNETAKA INDUSTRIAL MACHINERY	SAKURAI	- DAIWA PLASTICS
- TATSUMIKASEI	ASSOCIATION (CHUBU)	MURAKOSHI	SANEI MOLD	- FUJITSUKA
- TAMANO KASEI	- EAGLE ASSOCIATION	MURATA MACHINERY	SANKEI DIE & MOLD INDUSTRY	PRECISION MOLD
- CHUBU EXTRON	- IKEX INDUSTRY	MURATEC INFORMATION SYSTEMS	SANKO	- MATEX
- TOYO KAGAKU	- UCHIYAMA SEIKO	MUROMOTO TEKKO	SANKO SHOJI	WOJIN PLAIMM
- TOYORIKO	- KTX	<b>N</b>	SANYO NETSU KOGYO	WOOSUNG ENG
- TOWA LITE INDUSTRY	- SANSYU FINETOOL	NABELL	SAXIN	<b>Y</b>
- TOYAMA PREFECTURAL PLASTIC INDUSTRIES ASSOCIATION	- TAKAHASHI SEIKI	NAGAHORI INDUSTRY	SEIDENSHA	YABUUCHI INDUSTRY
- NAGOYA MUNICIPAL INDUSTRIAL RESEARCH INSTITUTE	- TANAKA DIE & MOLD WORKS	NAGATSU PRECISION MOLD	ELECTRONICS	YAMADEN
- MIZUHO PLASTICS INDUSTRIES	- NAGOYA PRECISION MOLD	SEKIGUCHI TEKKOJO	SEKIGUCHI TEKKOJO	YAMAGUCHI DENZAI
CHUETSU PULP & PAPER COMNET	JFE TECHINO RESEARCH	SHENZHEN KOMENG	SHENZHEN KOMENG	YAMAICHI SPECIAL
CRAFT	JSOL	PRECISION MOLD	SHIBAUURA MACHINE	STEEL
<b>D</b>	JUJU CHEMICAL	SHIBAUURA MACHINE	SINTOKOGIO	YAMAKI DENKI
DAIEI INDUSTRIAL	<b>K</b>	SODICK	SOL	YAMASHITA ELECTRIC
DAIICHISEIKOUSHI	KAERCHER JAPAN	SOMAX	STAR SEIKI	YASUDA SANGYO
DJK	KALAYAN	STAR TECHNO	STAR TECHNO	YONEYAMA MOLD
DUSON INTERNATIONAL	KANAYAMA KASEI	STOLZ	STOLZ	YOSHIZAWA LIME INDUSTRY
- GREEN POWER JUICE	KANETSU THERMAL ENG.	SUMITOMO HEAVY INDUSTRIES	STOLZ	YUSHIN PRECISION EQUIPMENT
- CMS	KANSAI ELECTRIC HEAT	<b>Z</b>	<b>123</b>	<b>Z</b>
- GATC	KASHIYAMA KANAGATA INDUTRY	ZEN	3D WELDLESS ALLIANCE (MITSUBISHI CORPORATION TECHNOS)	<b>Z</b>
- JINHUNG IND.	KATSULON	<b>123</b>		
- ADVANCED MEDICAL INSTITUTE	KAWAGUCHI KOUSAN			
- FABRICA ASSOCIATES	KAWATA MFG.			
<b>E</b>	KEBA JAPAN			
EDLUND INDUSTRY	KISTLER JAPAN			
EMERSON JAPAN	KOSMEK			
	KOTANI			
	KOUNAN			
	KURARAY PLASTICS			
	KYOWA KOGYO			
	KYUSYU DAIEI INDUSTRIES			
	<b>L</b>			
	LEISTER TECHNOLOGIES			
	LUBE			
	<b>M</b>			
	MAEGAWA MOLD			
	MARUBENI			
	INFORMATION SYSTEMS			
	MARUSAN KINZOKU			
	NTC			

## TOP 100 Visitor Companies

1 TOYOTA MOTOR	34 YAZAKI	67 KASAI MILL
2 TSUCHIYA	35 KOJIMA	68 SANYO SEISAKUSHO
3 AISIN SEIKI	36 KATECS	69 ISONO
4 DENSO	37 ASAMA FACTORY	70 ASAHI ELECTRIC
5 TOKAIRIKA	38 INOAC	71 KITAGAWA INDUSTRIES
6 DAIWA KASEI INDUSTRY	39 AICHI TOKEI DENKI	72 AOYAMA SEISAKUSHO
7 RHOMBIC	40 CKD	73 ASAHI KASEI
8 TOYOTA BOSHOKU	41 YAHAGI INDUSTRY	74 GIFU PLASTIC INDUSTRY
9 KOJIMA INDUSTRIES	42 MATSUO INDUSTRIES	75 SUZUKI CHEMICAL INDUSTRY
10 MITSUBISHI ELECTRIC	43 CHUBU PLASTICS MOLDING	76 HAMANAKODENSO
11 NIFCO	44 TAKARA KASEI KOGYO	77 ARONKASEI
12 AISAN INDUSTRY	45 AIYO SANGYO	78 SHO-KO PLASTIC
13 TAIYO SANGYO	46 SANWA INDUSTRY	79 NITTO KOGYO
14 GOMUNOINAKI	47 ONDA MFG.	80 CHUBU EXTRON
15 TOYODA GOSEI	48 YAMAHA MOTOR	81 JAPAN POLYPROPYLENE
16 SUMITOMO WIRING SYSTEMS	49 YAZAKI KAKO	82 ASAHI RIKA
17 TOYO	50 SANKYO KASEI SANGYO	83 FUJI ELECTRIC
18 TAITEC	51 AIPI SEIMITSU	84 TOYOTA INDUSTRIES
19 TOKAI KOGYO	52 TAMANO KASEI	85 KYORAKU
20 BROTHER INDUSTRIES	53 NIPPLA	86 SHIMIZU INDUSTRY
21 YAMASO	54 IKEX	87 KENSETSU RUBBER
22 DAIICHI JITSUGYO	55 SANKO GOSEI	88 TENMA
23 LIXIL	56 MEISHIN ELECTRIC	89 MEIJI ELECTRIC INDUSTRIES
24 DAIWA DENKA	57 OKAYA	90 SANKO
25 MIE METAL INDUSTRY	58 HOWA	91 KUNIMORI KAGAKU
26 PANASONIC	59 HAJIME INDUSTRY	92 TOKAI CHEMICAL INDUSTRY
27 FTS	60 CHURYO ENGINEERING	93 CATEYE
28 FISA	61 NAGOYA MUNICIPAL INDUSTRIAL RESEARCH INSTITUTE	94 B.M.G.
29 SANKO KASEI	62 NIPPO	95 INABATA
30 TOYOTA AUTO BODY	63 MANNOH INDUSTRIAL	96 NISSIN KOGYO
31 TOPPAN PRINTING	64 TOYODA IRON WORKS	97 PACIFIC INDUSTRIAL
32 TOGO SEISAKUSYO	65 MEIHOU KASEI	98 HAYASHI TELEMPU
33 HOWA PLASTICS	66 UKAI INDUSTRY	99 TOYOJYUSHI
		100 NIKKO LITE INDUSTRIAL

## Visitor Survey Results of 2018 (Previous Show) Total Visitors Over 3 days: 18,662 (Including the Co-located Show)

### Visitor Occupations

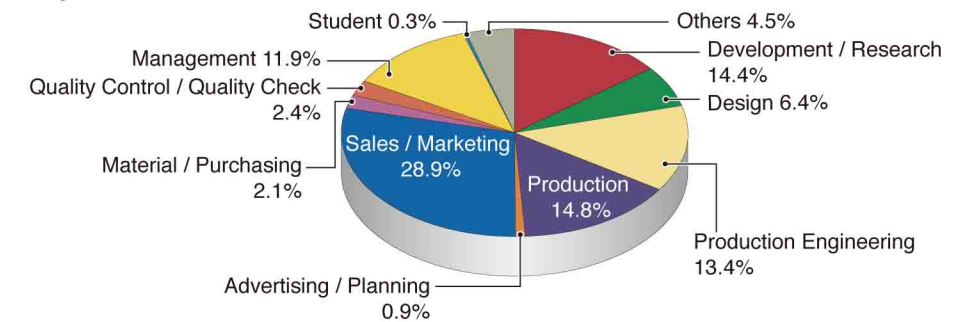

### Visitor Industries

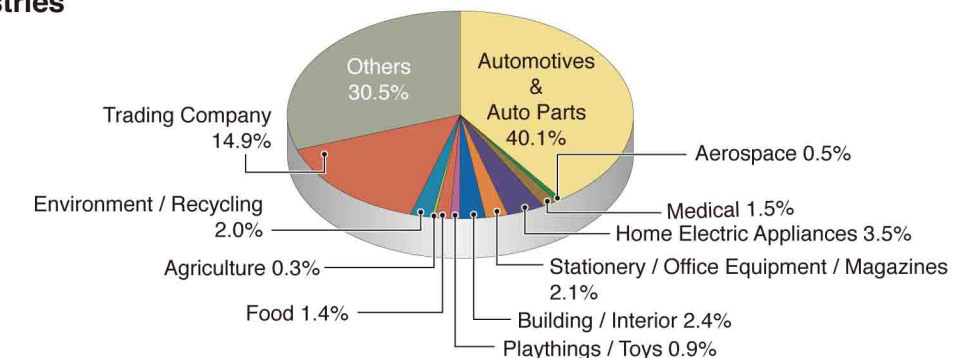

## Optimal Use of the "Daily Industrial News" Media for Promotion

Optimization of not only the "Daily Industrial News" but also various other mediums to attract high quality visitors.



Exhibitor interview articles in addition to special features on the show (only selected interviews will be printed).



Invitations sent to domestic and foreign related companies and organizations included on the DM list of the Daily Industrial News (approx. 200,000 invitations).



We will encourage more visitors with the use of various other tools!



Advertisements in public transportation  
 - Posters hanging on the Nagoya Municipal Subway  
 - Advertisements in JR Tokai (Central Japan Railway) trains  
 - Posters at JR stations



Articles and advertisements published periodically on industrial magazines.

### Exhibitor introductions on the official website

Introductions to all exhibitors and links to company websites will be displayed on the official event website, providing detailed information on its participants.



### Access

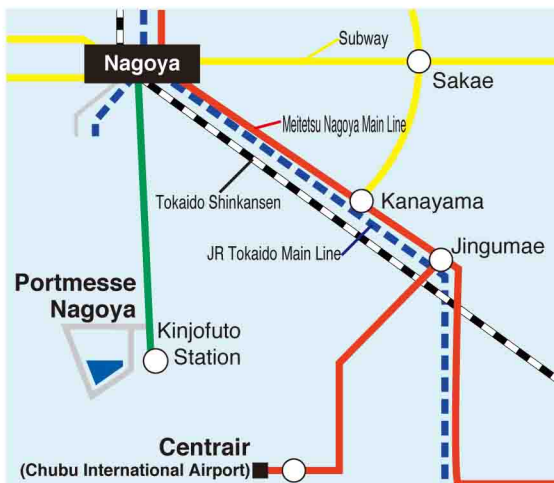

### Exhibition Schedule

April 30th	Exhibitor application deadline
Late August	Final deadline for various documents
September 26th through 28th	Delivery and installation of exhibits
September 29th through October 1st	Event
October 1st through 2nd	Dismantling and removal of exhibits

■ Exhibitor application deadline: April 30th, 2021  
 Please note that the list will be closed before the deadline once all available spaces are fully booked.



Nagoya Plastic Industrial Fair 2021 Office  
 c/o Nikkan Kogyo Shimbun Nagoya Branch  
 Email: nk-event@media.nikkan.co.jp

■ Overseas Agent

**ACT INTERNATIONAL, INC.**

TEL: +81-3-5770-5581 FAX: +81-3-5770-5583

Email: exhibition@actinter.co.jp

https://nagoya-platen.com/